

SOJAG ■■

produits saisonniers • seasonal products

IMPORTANT, RETAIN FOR FUTURE REFERENCE: READ CAREFULLY

Wichtig: für den zukünftigen Gebrauch aufbewahren: sorgfältig lesen.

WAŻNE, ZACHOWAĆ DO WYKORZYSTANIA W PRZYSZŁOŚCI: PRZECZYTAJ UWAŻNIE

FONTOS, ŐRIZZE MEG A JŐVŐBENI REFERENCIÁNAK: TELJESEN OLVASSA EL

DŮLEŽITÉ, UCHOVEJTE SI JE PRO BUDOUCÍ POUŽITÍ: ČTĚTE POZORNĚ

DŔLEŽITÉ, UCHOVAJTE SI ICH PRE BUDÚCE POUŽITIE: POZORNE SI PREČÍTAJTE

Assembly Manual / Montageanleitung / Instrukcja montażu / Telepítési útmutató / Montážní návod / Inštalačné pokyny

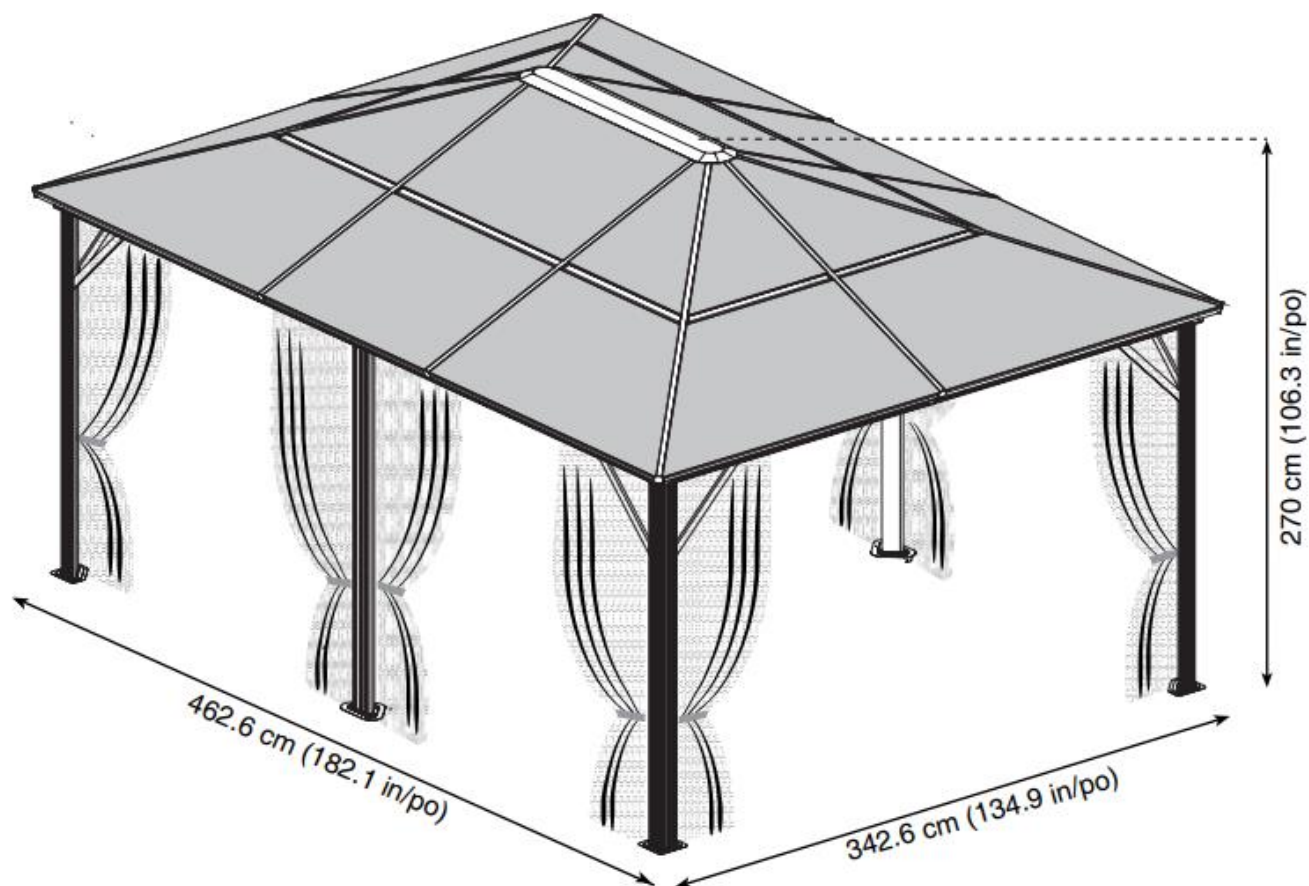

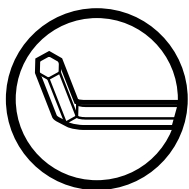

Use the hex keys in the box. / Verwenden Sie die Inbusschlüssel in der Schachtel./
Użyj kluczy sześciokątnych znajdujących się w pudełku. / Használja a dobozban
lévő hatlapos kulcsokat/ Použijte šestihranného klíče v krabici. / Použijte
šest'hranný klíč v krabici.

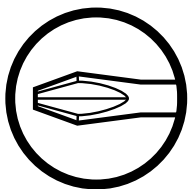

Please use a Phillips screwdriver. / Bitte verwenden Sie einen
Kreuzschraubenzieher. / Należy używać śrubokręta krzyżakowego. / Kérjük,
használjon Phillips csavarhúzó. / Použijte křížový šroubovák. / Použijte
křížový skrutkovač.



You may need to use a drill for this step. / Für diesen Schritt können Sie einen Bohrer
verwenden. / Na tym etapie może być konieczne użycie wiertarki. / Lehet, hogy fúrót
kell használnia ehhez a lépéshez. / Pro tento krok může být nutné použít vrtačku. / Pri
tomto kroku môže byť potrebné použiť vrtačku.



Wearing protective gloves is recommended. / Das Tragen von Schutzhandschuhen wird
empfohlen. / Zaleca się noszenie rękawic ochronnych. / Védőkesztyű viselése ajánlott. /
Doporučuje se nosit ochranné rukavice. / Odporúča sa nosiť ochranné rukavice.



Two or more people are required at this stage. / Für diesen Bauschritt sind 2 oder mehr
Personen erforderlich. / Na tym etapie wymagane są co najmniej dwie osoby. /
Ebben a szakaszban két vagy több emberre van szükség. / V této fázi jsou zapotřebí dvě
nebo více osob. / Skrutky zatiaľ úplne neutiahnite.



Do not tighten screws all the way for now. / Bitte die Schrauben zum jetzigen Zeitpunkt
noch nicht fest anziehen. / Na razie nie dokręcaj śrub do końca. / Egyelőre ne húzza
meg teljesen a csavarokat. / Šrouby prozatím nedotahujte úplně. /

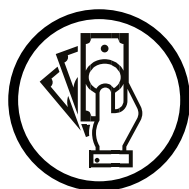

Sold separately. / Optional erhältlich. / Sprzedawane oddzielnie. / Külön eladva. /
Prodává se samostatně. / Predáva sa samostatne.

For Outdoor Use only. Not for Commercial Use

Nur für den Gebrauch im Freien. Nicht für den kommerziellen Gebrauch geeignet

Tylko do użytku zewnętrznego. Nie do użytku komercyjnego

Csak kültéri használatra. Nem kereskedelmi használatra

Pouze pro venkovní použití. Není určeno pro komerční použití

Len na vonkajšie použitie. Nie na komerčné použitie

U X68(+6)

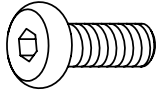

U1 X 52 (+5)

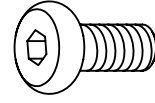

U2 X2 (+1)



V X 16 (+3)

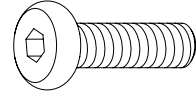

V1 X1 (+1)

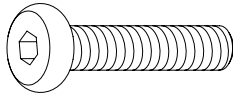

W X 16 (+2)

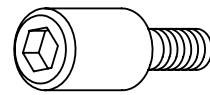

X X 10 (+2)

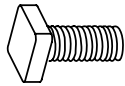

X1 X 30 (+6)



Y X 24 (+4)

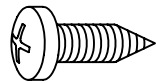

Y1 X 20 (+4)

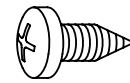

Z X1

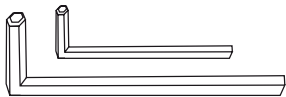

Z1 X2

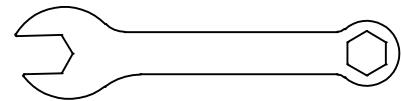



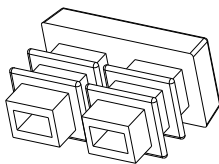





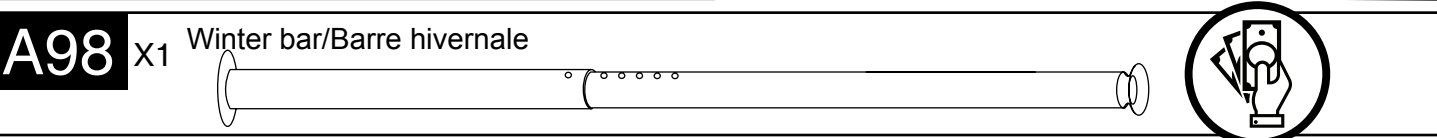
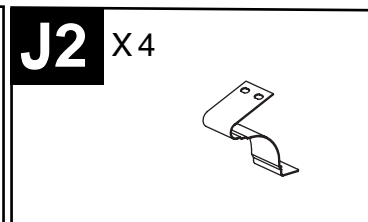
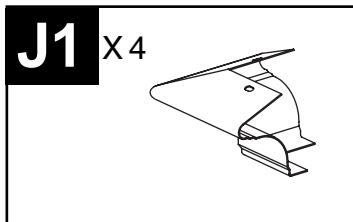
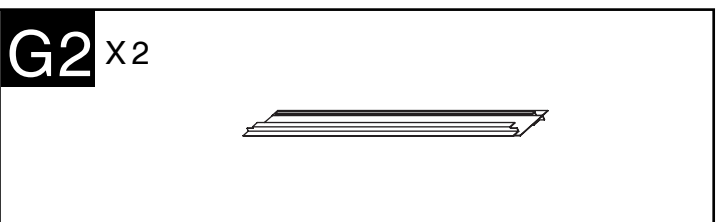
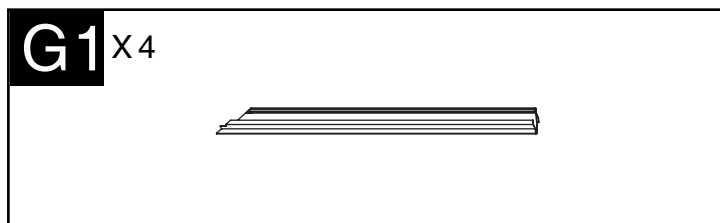
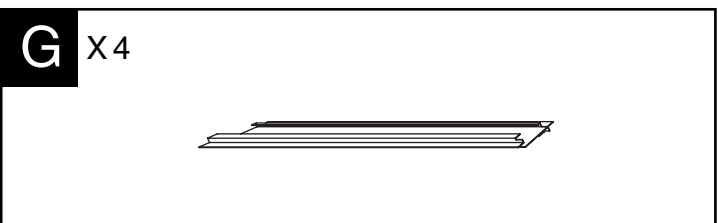
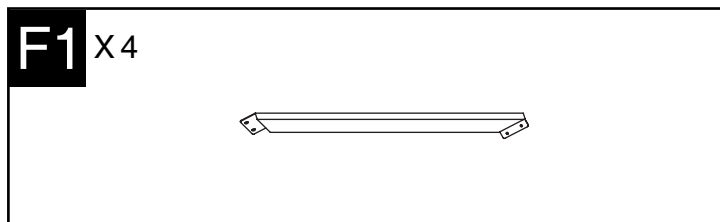
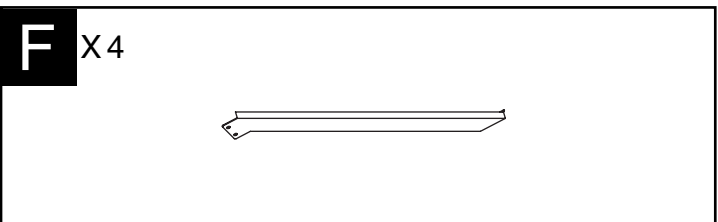
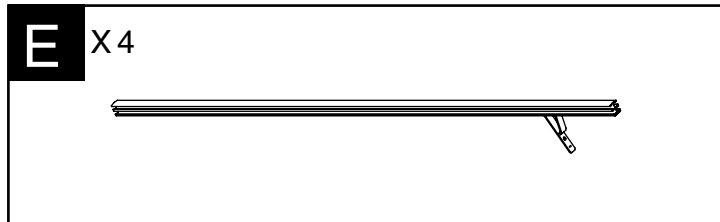
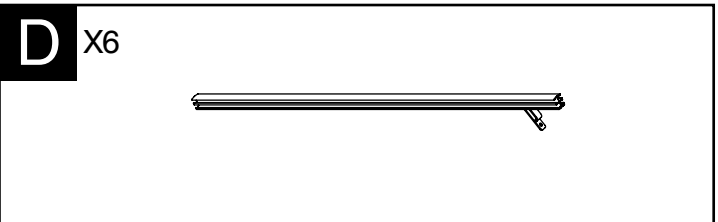
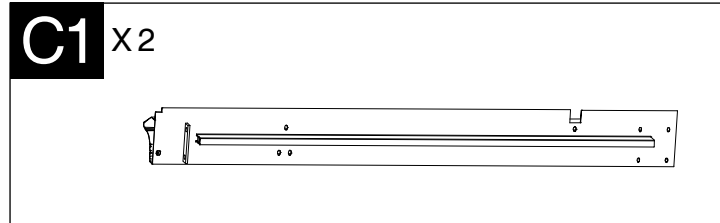
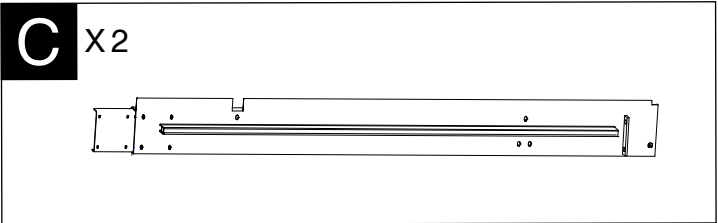
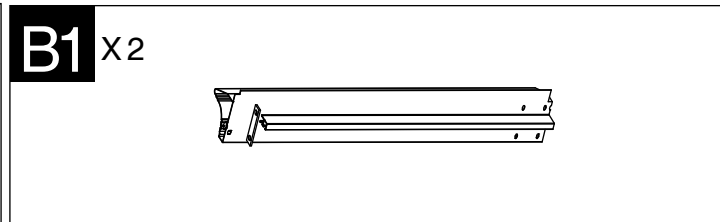
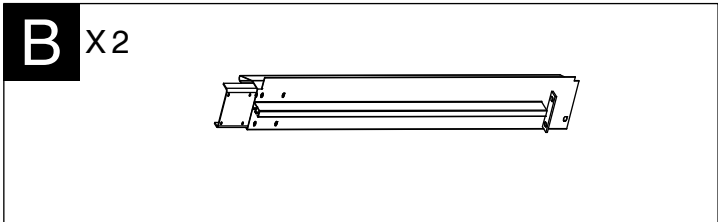
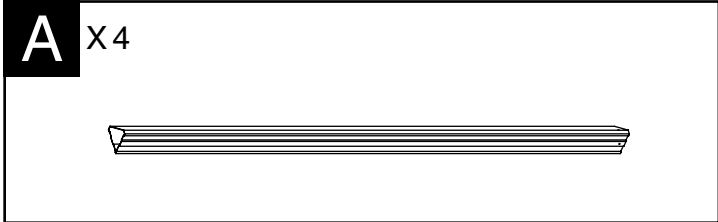







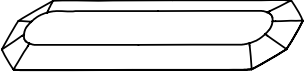
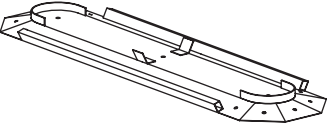
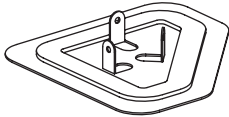
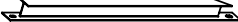
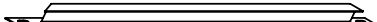
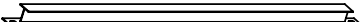

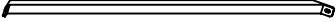
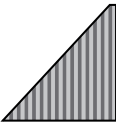
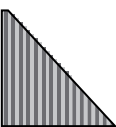
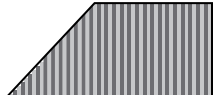
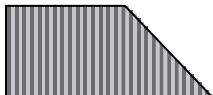

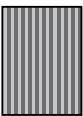
Z2 X4(+1)

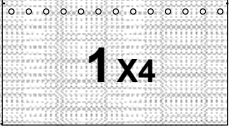
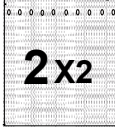

Z3 X8(+2)





H X4 	H1 X4 	H2 X2 
I X4 	I1 X4 	I2 X2 
K X1 	K1 X1 	L X6 
N X4 	N1 X4 	
N2 X2 	O X4 	O1 X6 
Q X4 	Ma X4 	M1a X4 
Mb X4 	M1b X4 	
P X2 	P1 X2 	T X 68 (+2) Optional  
		T X 68 (+2) Optional  
Net  1x4  2x2 	Optional 	Curtain  3x4  4x2 
		Optional 

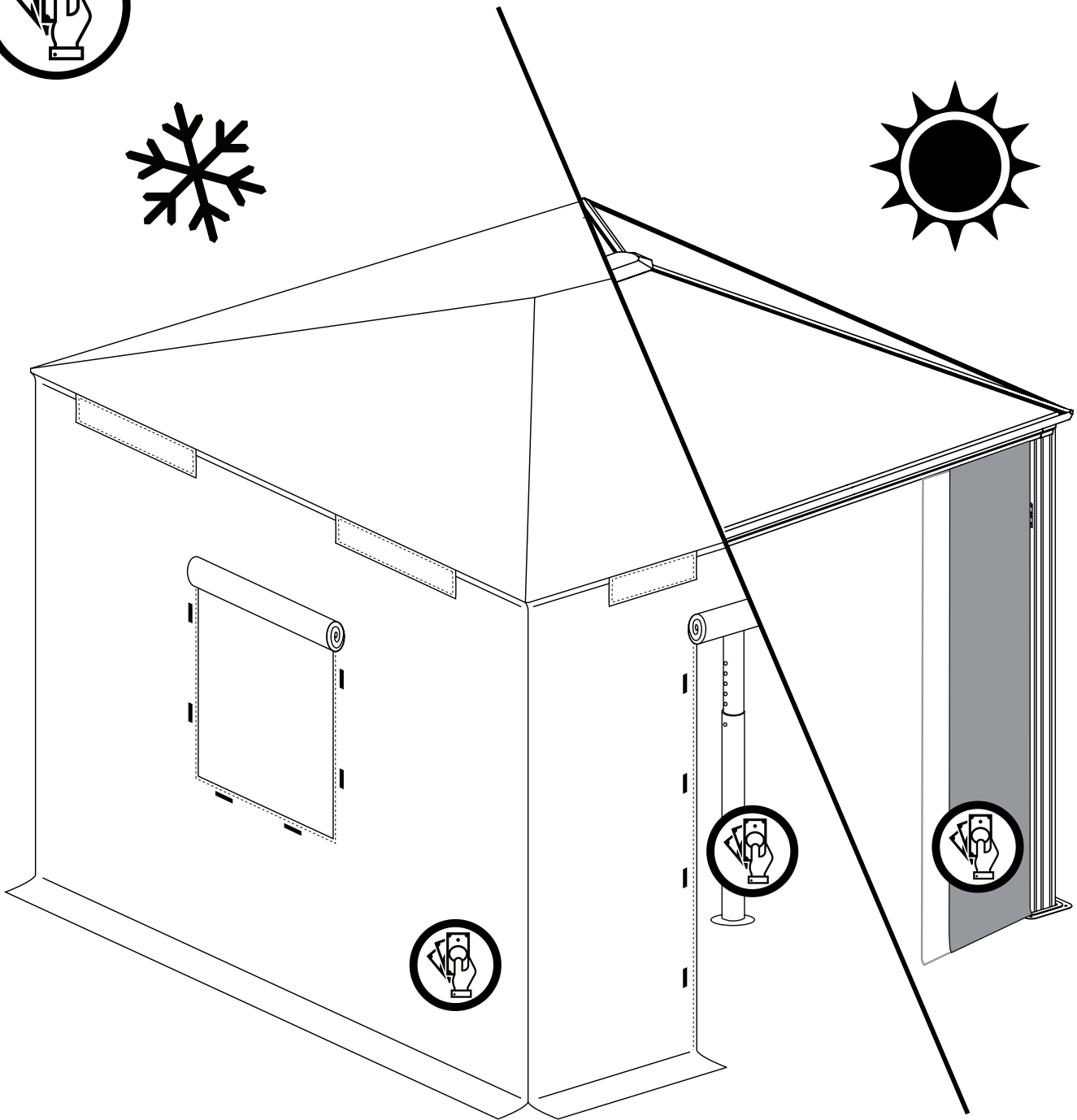
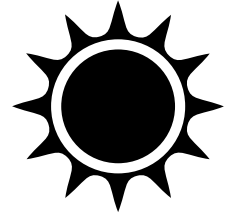
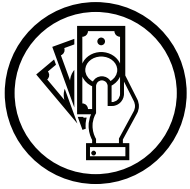

A98 x1



Rx1

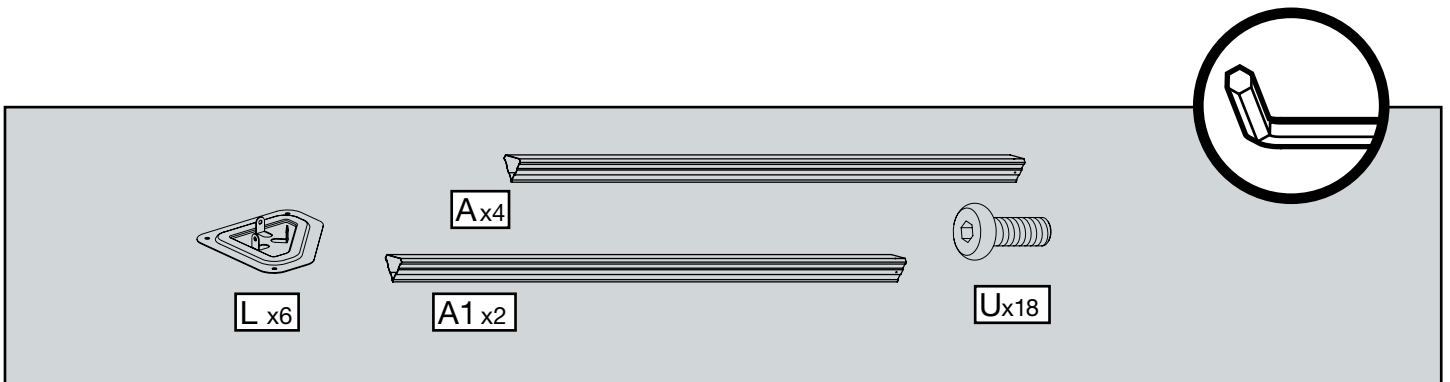
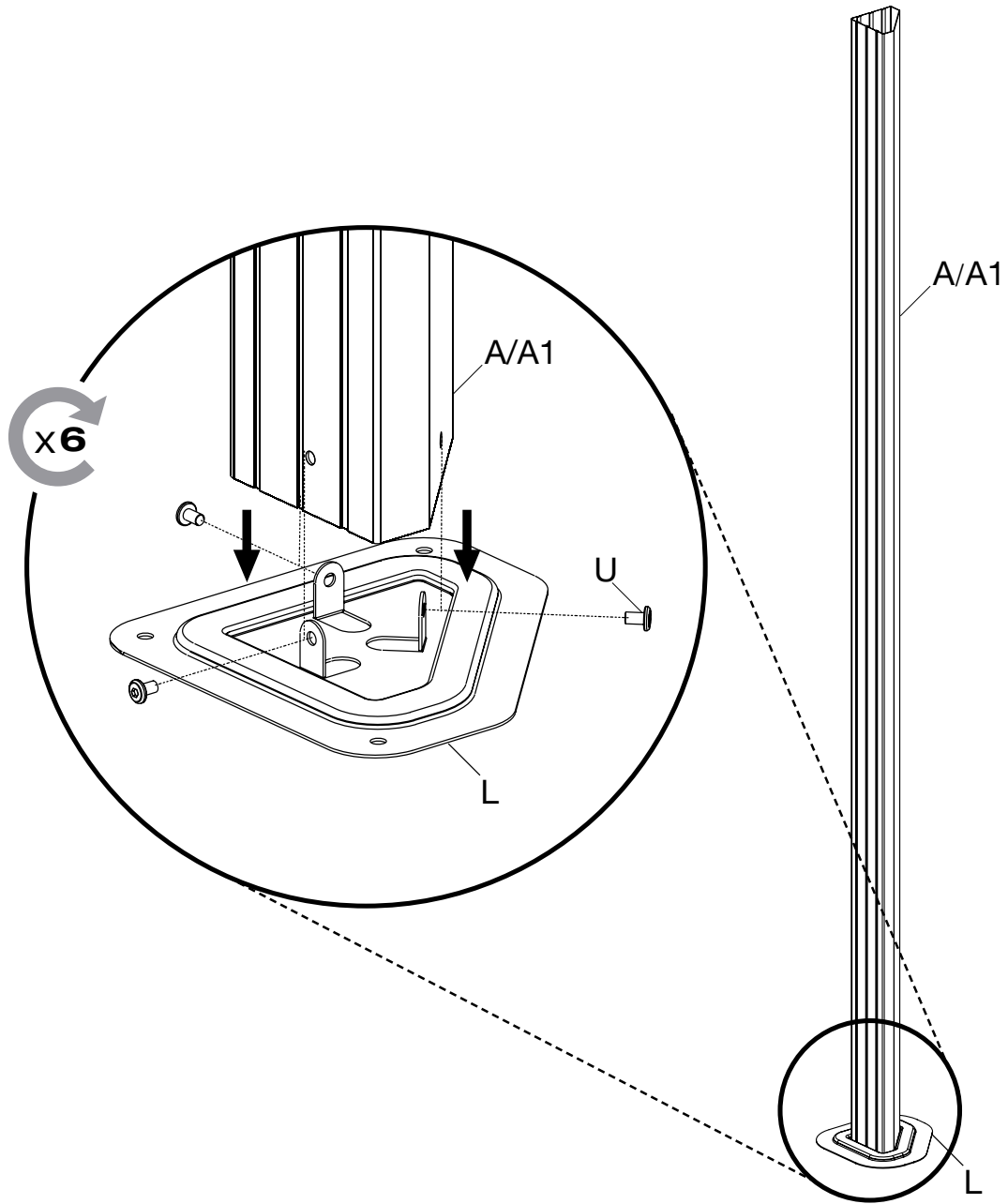

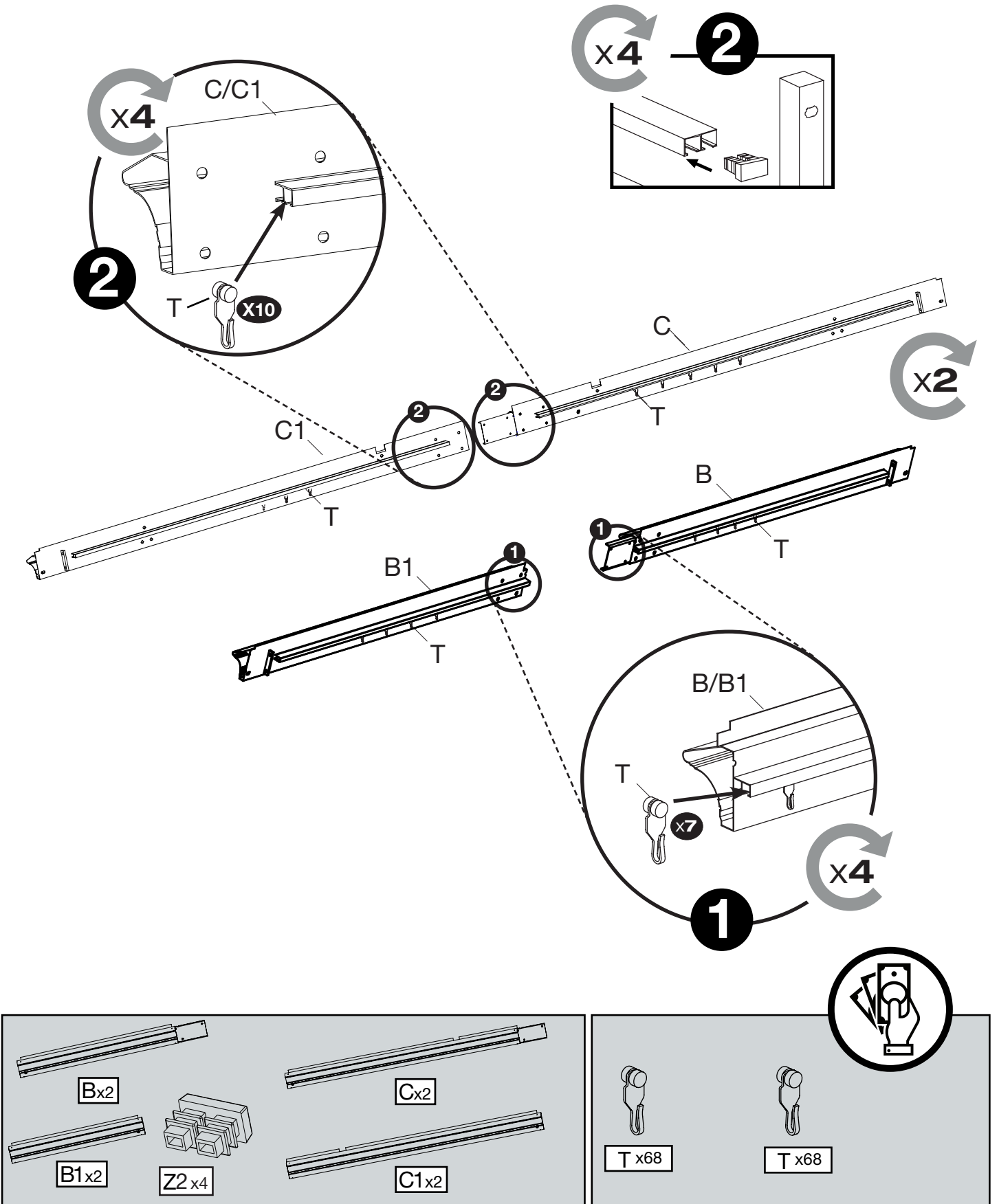

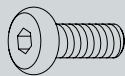
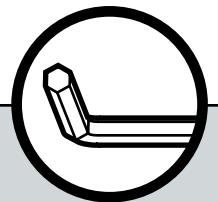
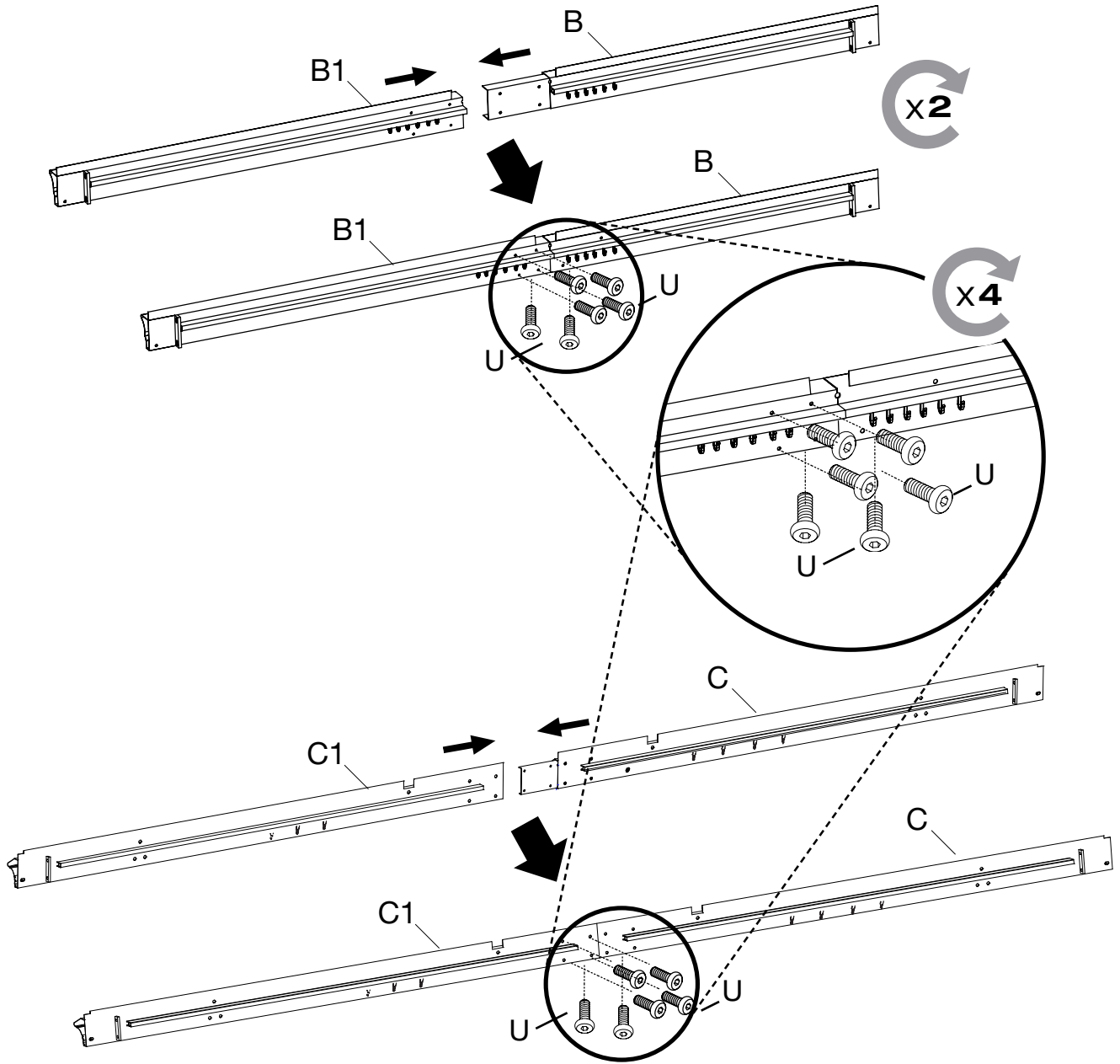

Ux24

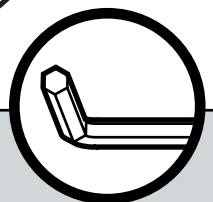
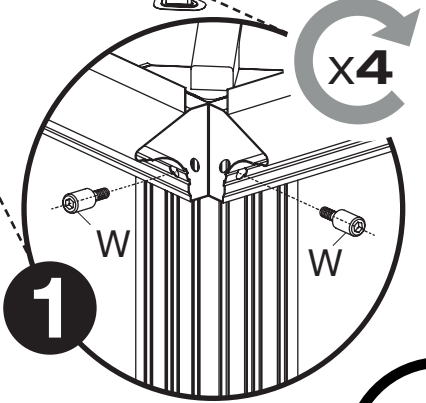
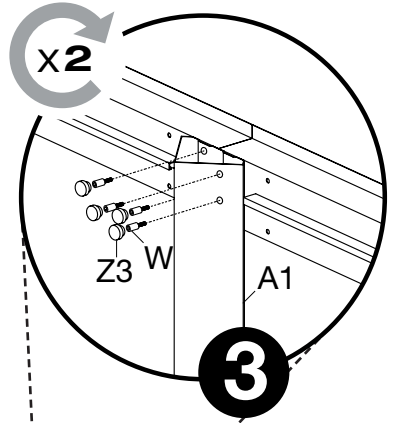
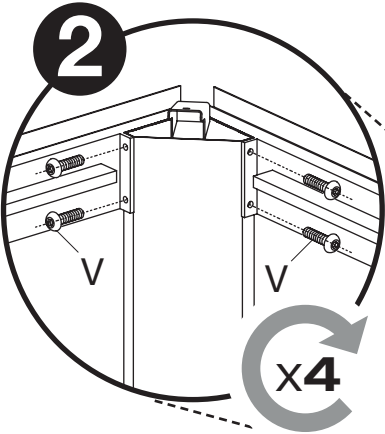
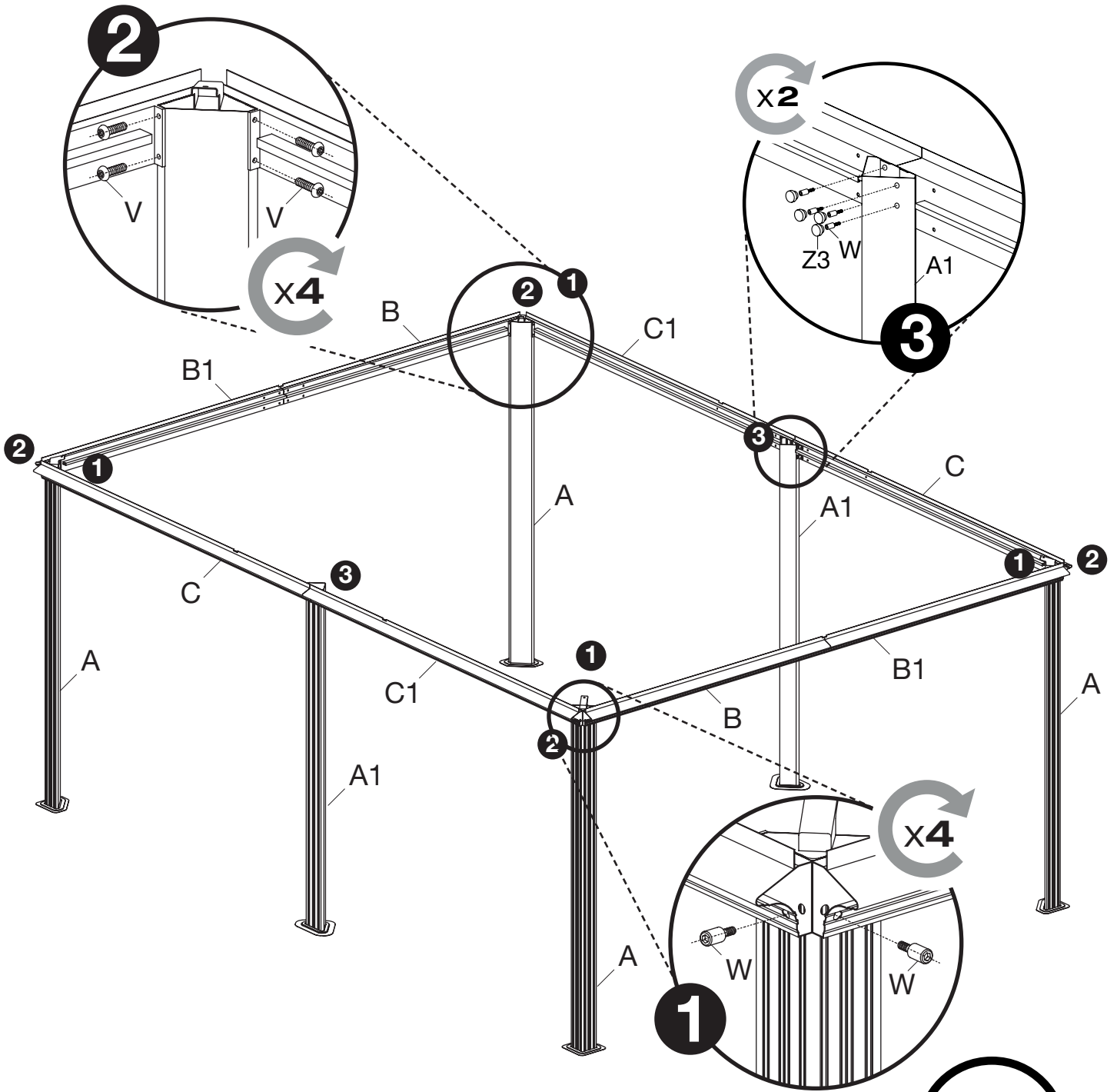

W x16 V x16 Z3 x8

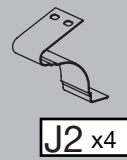
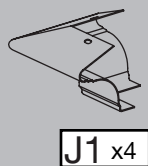
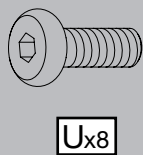
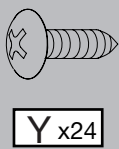
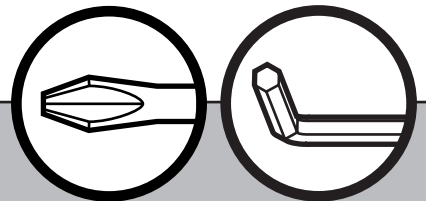
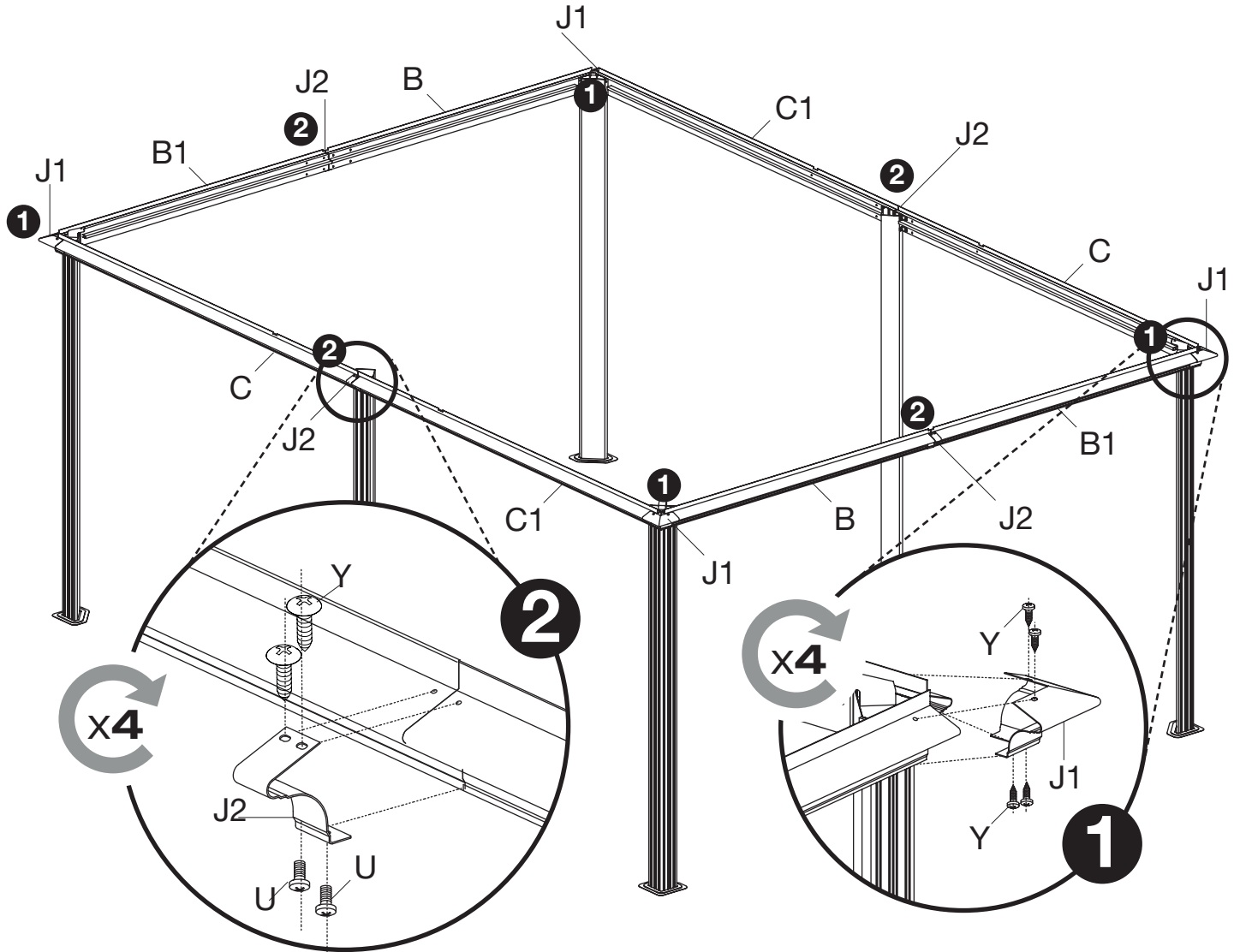

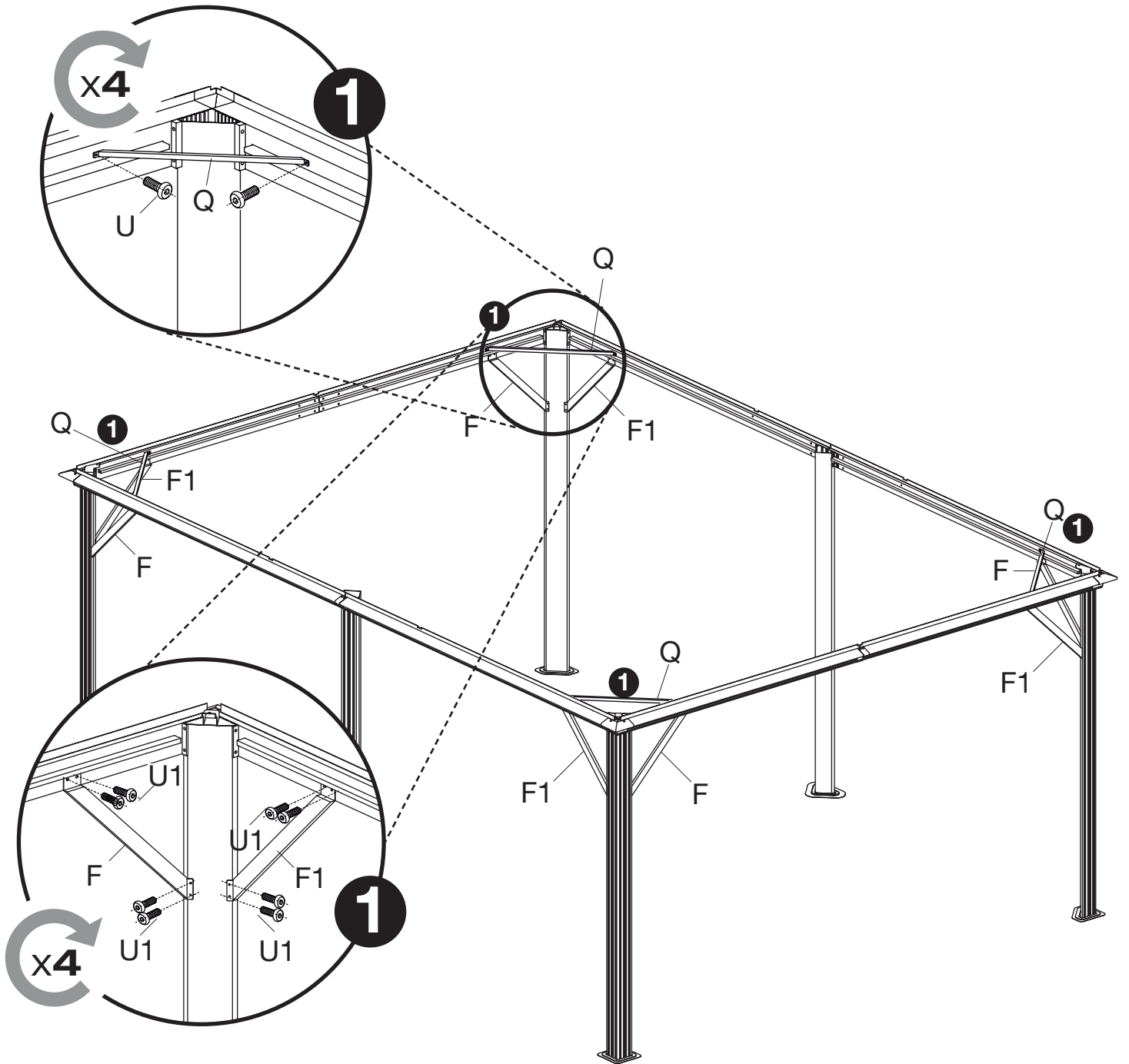

This section contains a parts list and an assembly tip. The parts list includes:

- Four beams labeled **F x4**
- Four cross-braces labeled **F1 x4**
- Four corner braces labeled **Q x4**
- Eight bolts labeled **U x8**
- Thirty-two bolts labeled **U1 x32**

To the right of the parts list is a circular icon containing a bent metal rod, representing the assembly tip.

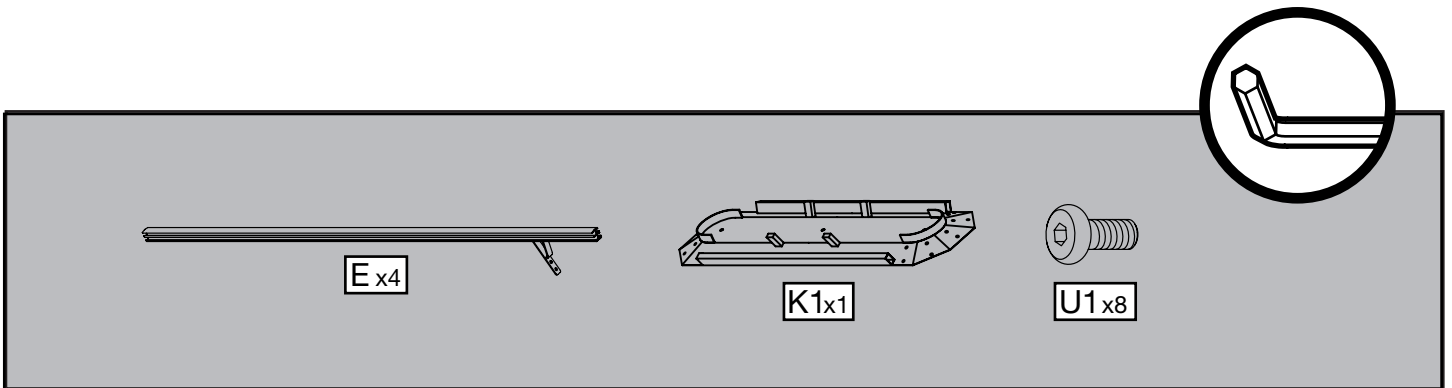
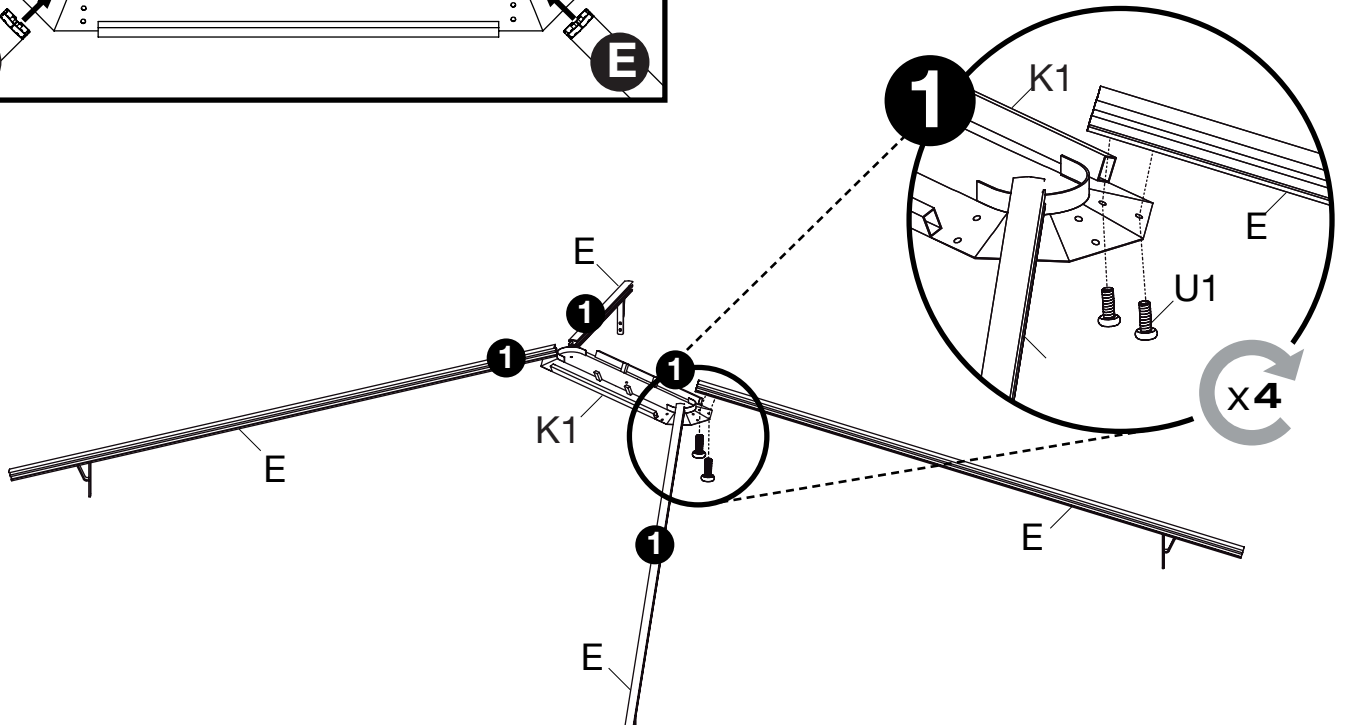
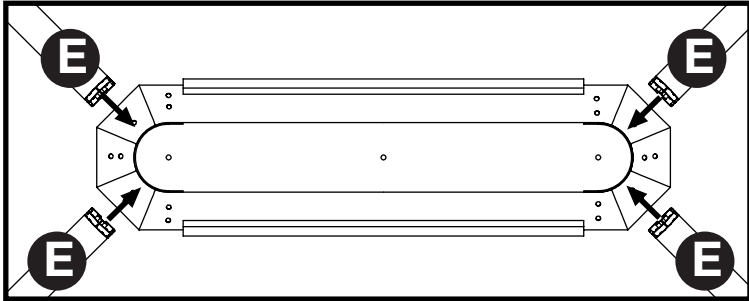

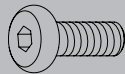
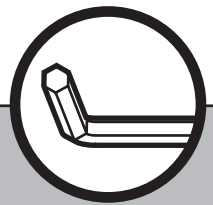
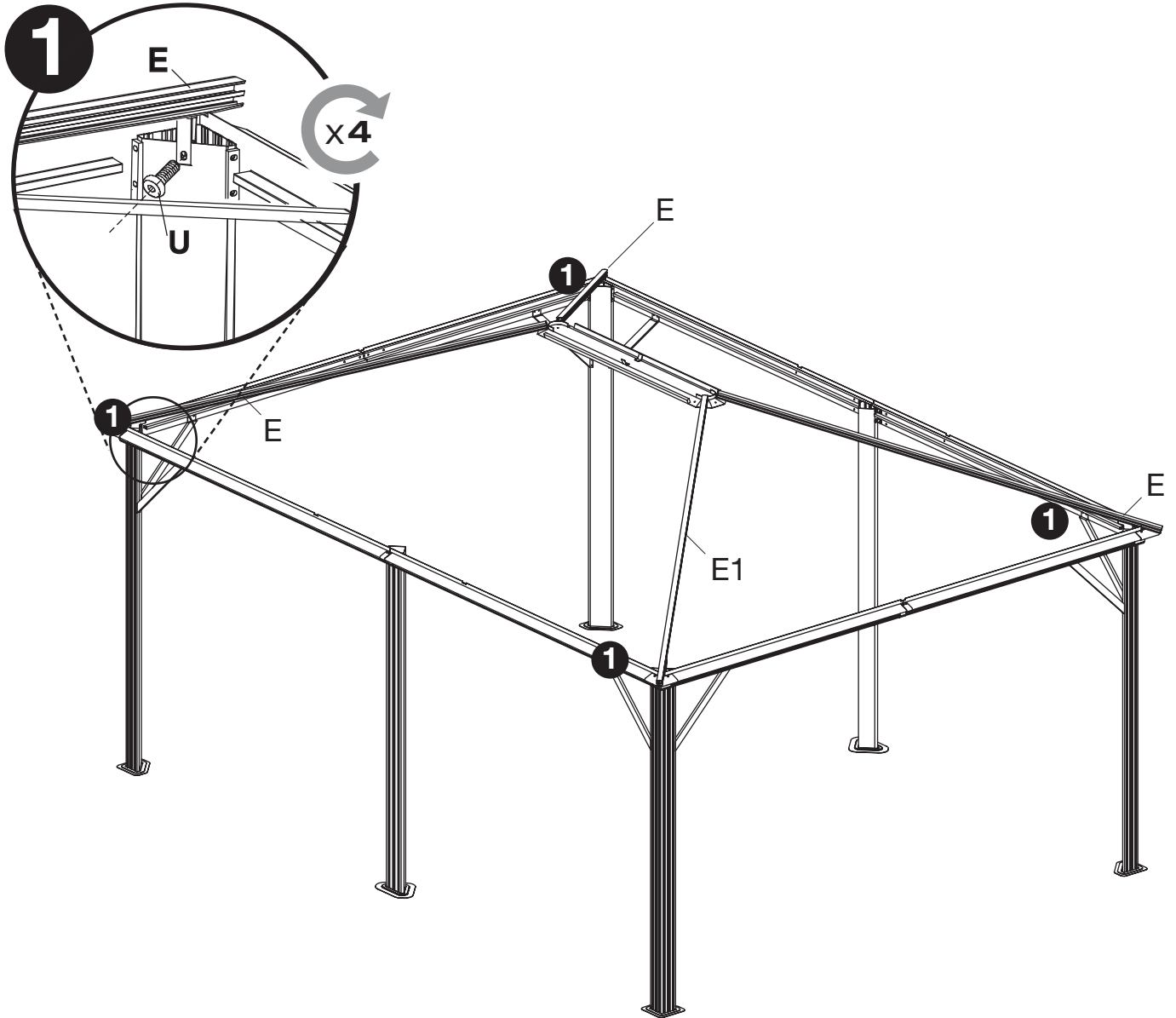

Ux4

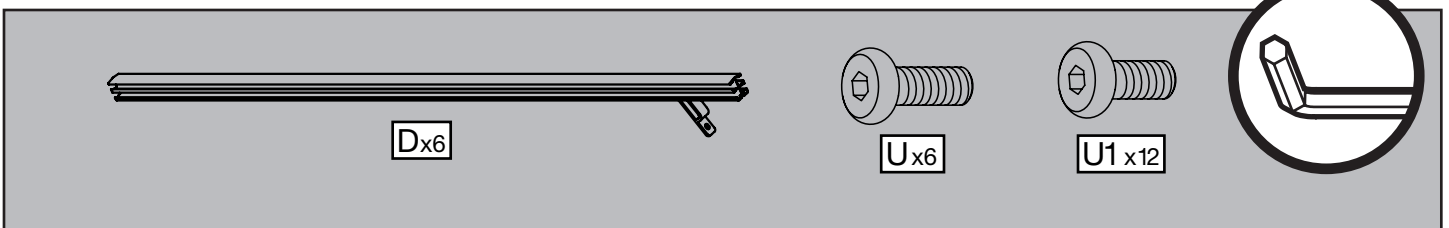
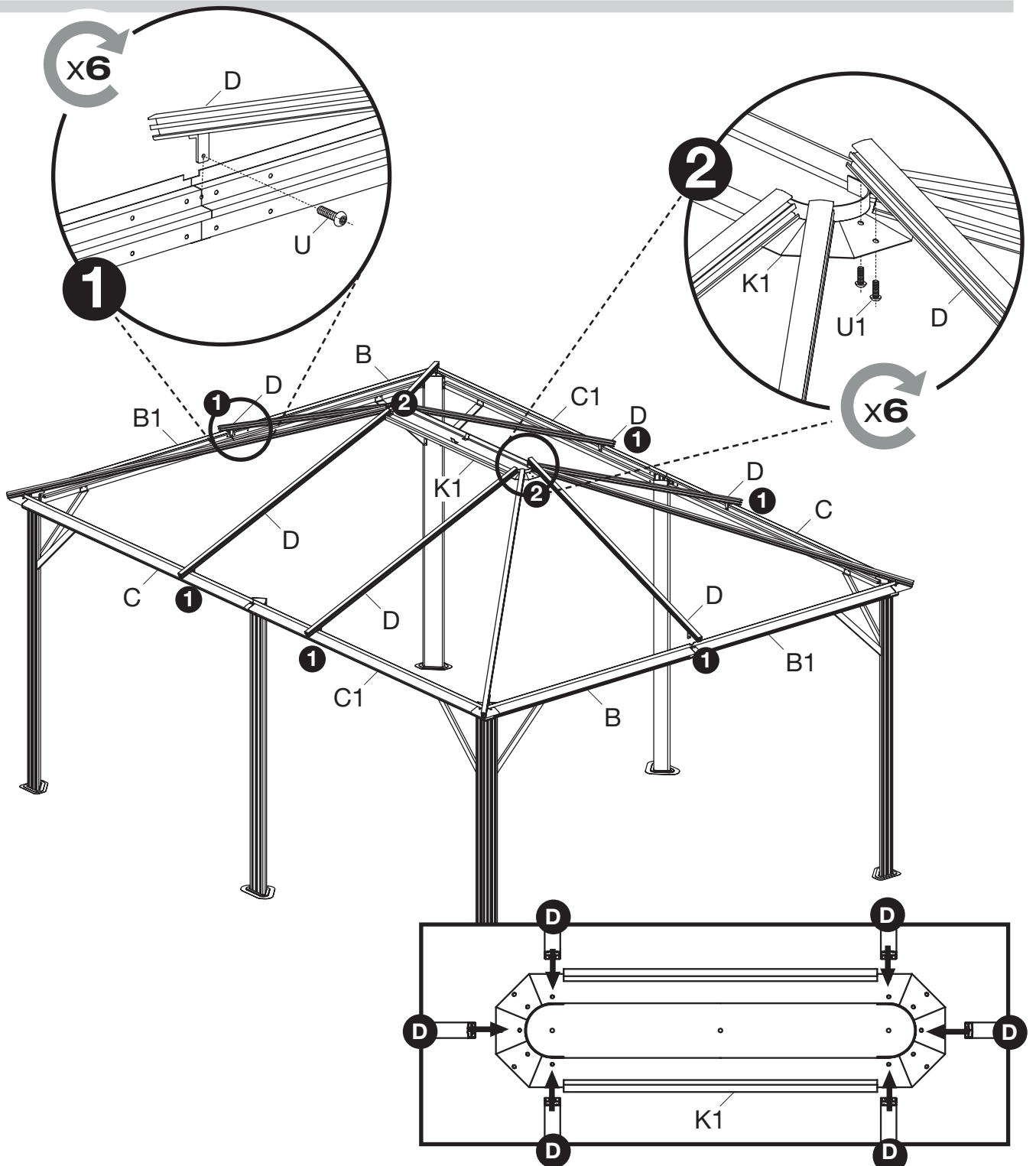

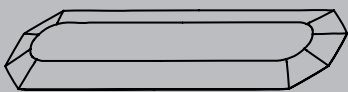
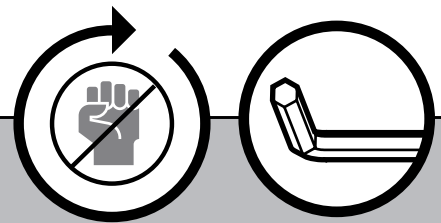
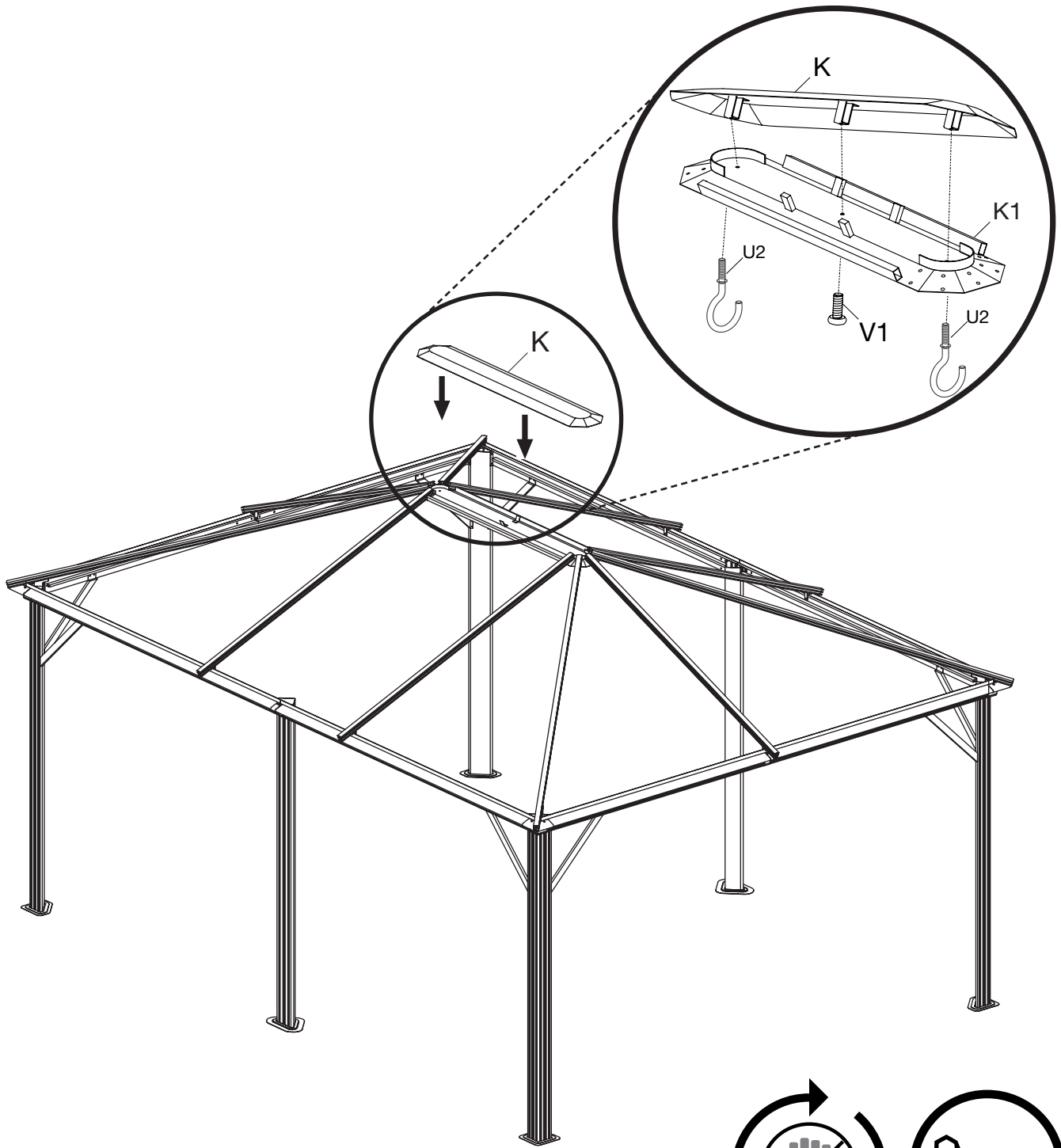

Kx1

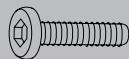

V1 x1



U2 x2

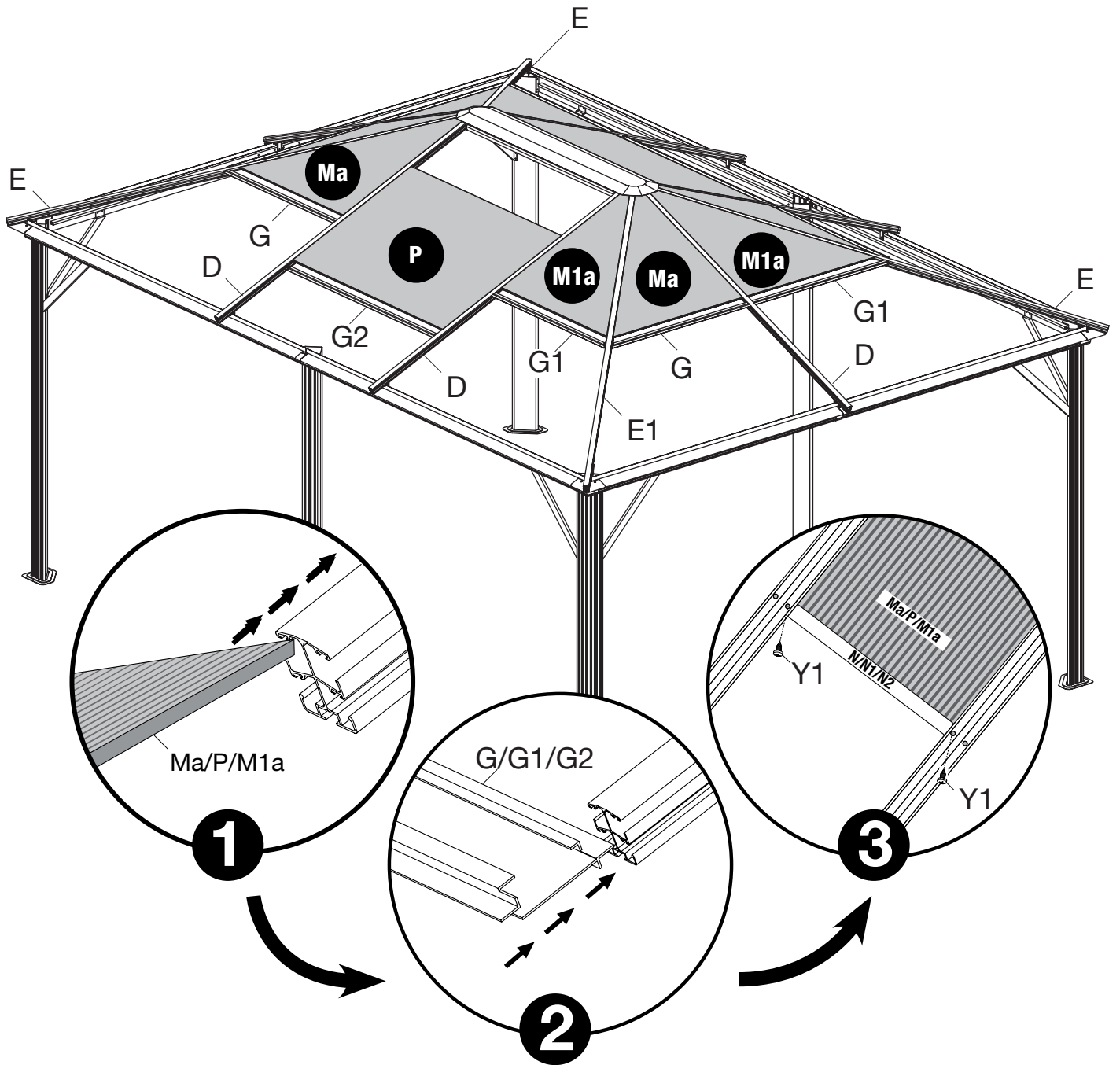

Parts list and safety icon:

- Ma x4
- P x2
- M1a x4
- Y1 x20
- G x4
- G1 x4
- G2 x2
- Safety icon: Hands

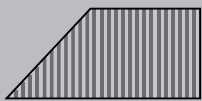
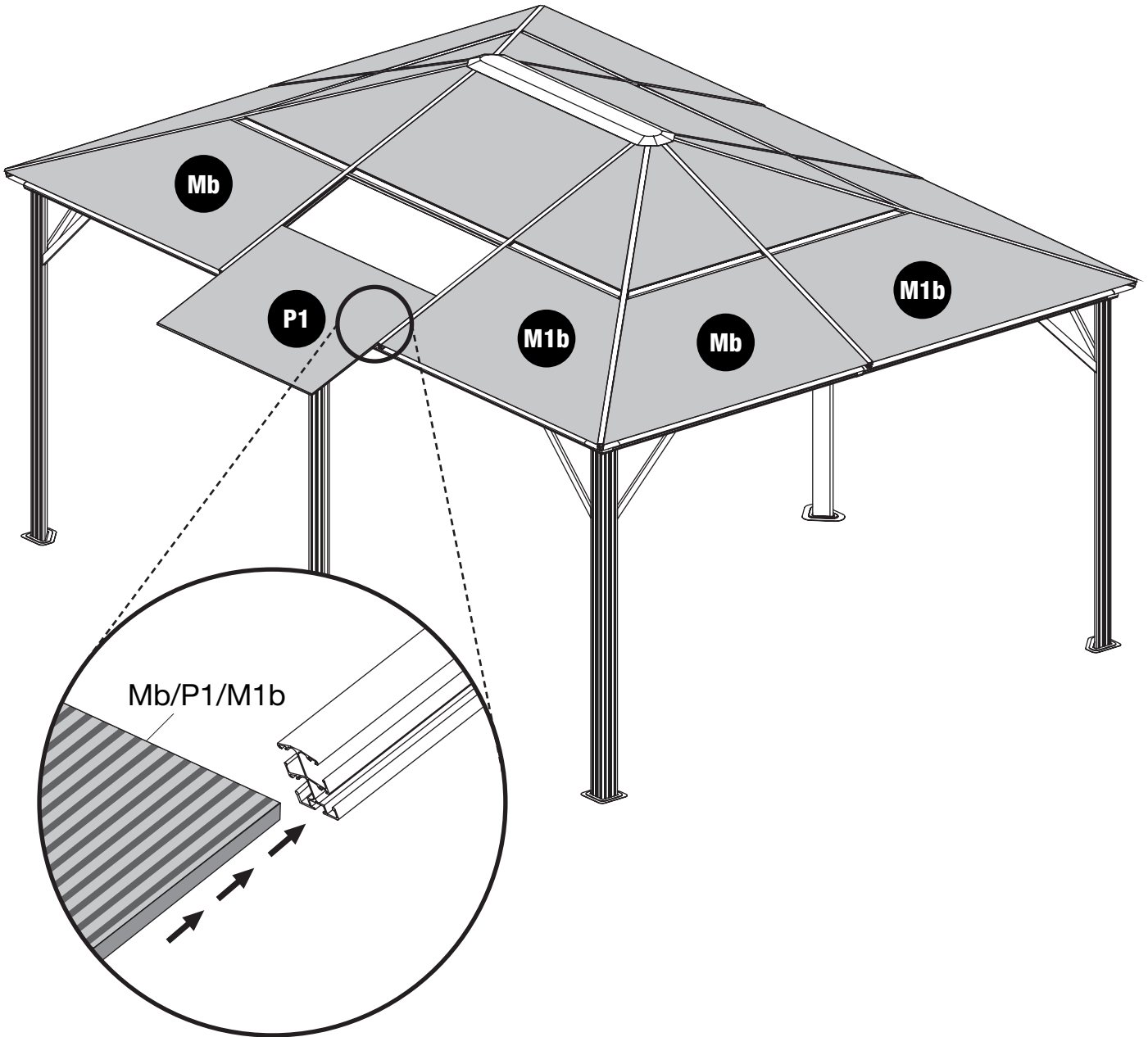

Mb_{x4}





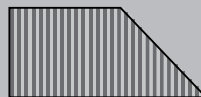

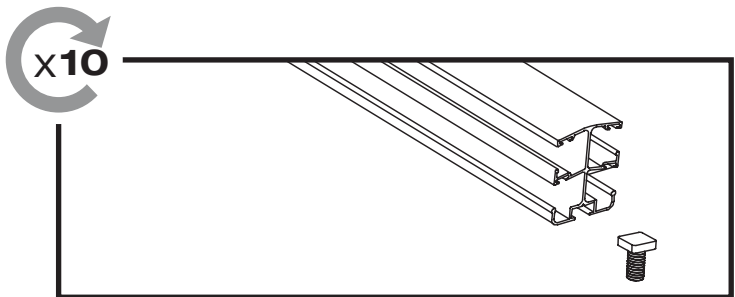
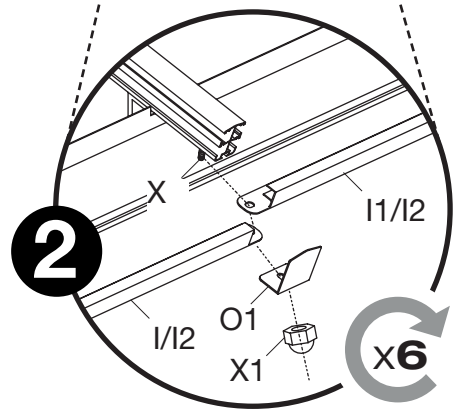
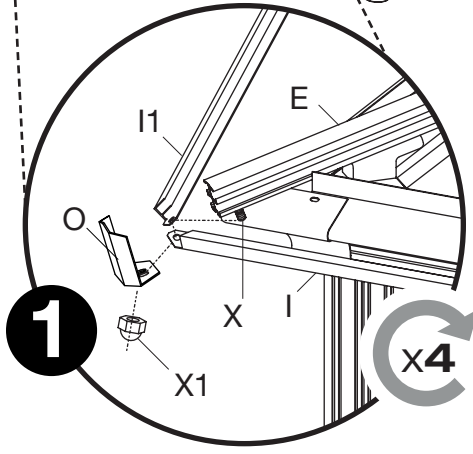
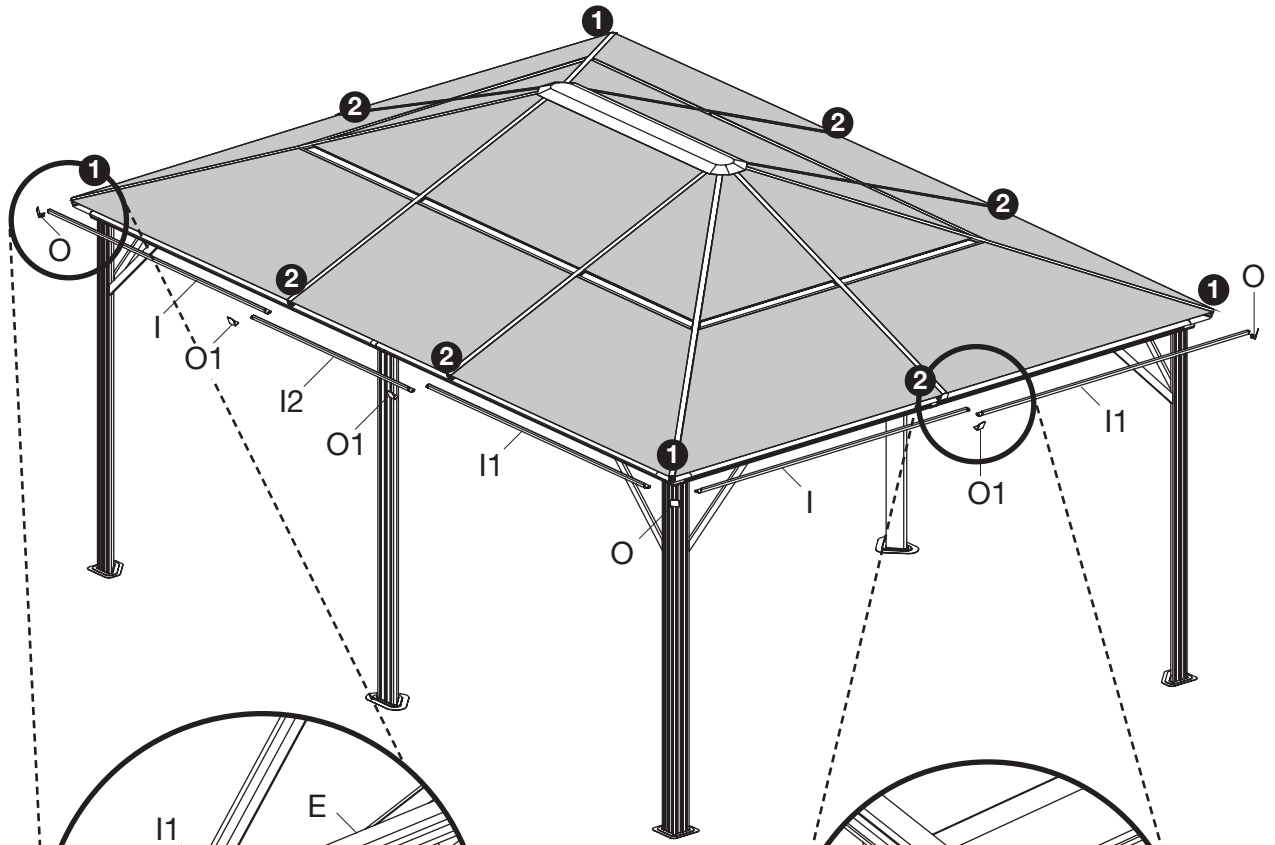

P1_{x2}







M1b_{x4}

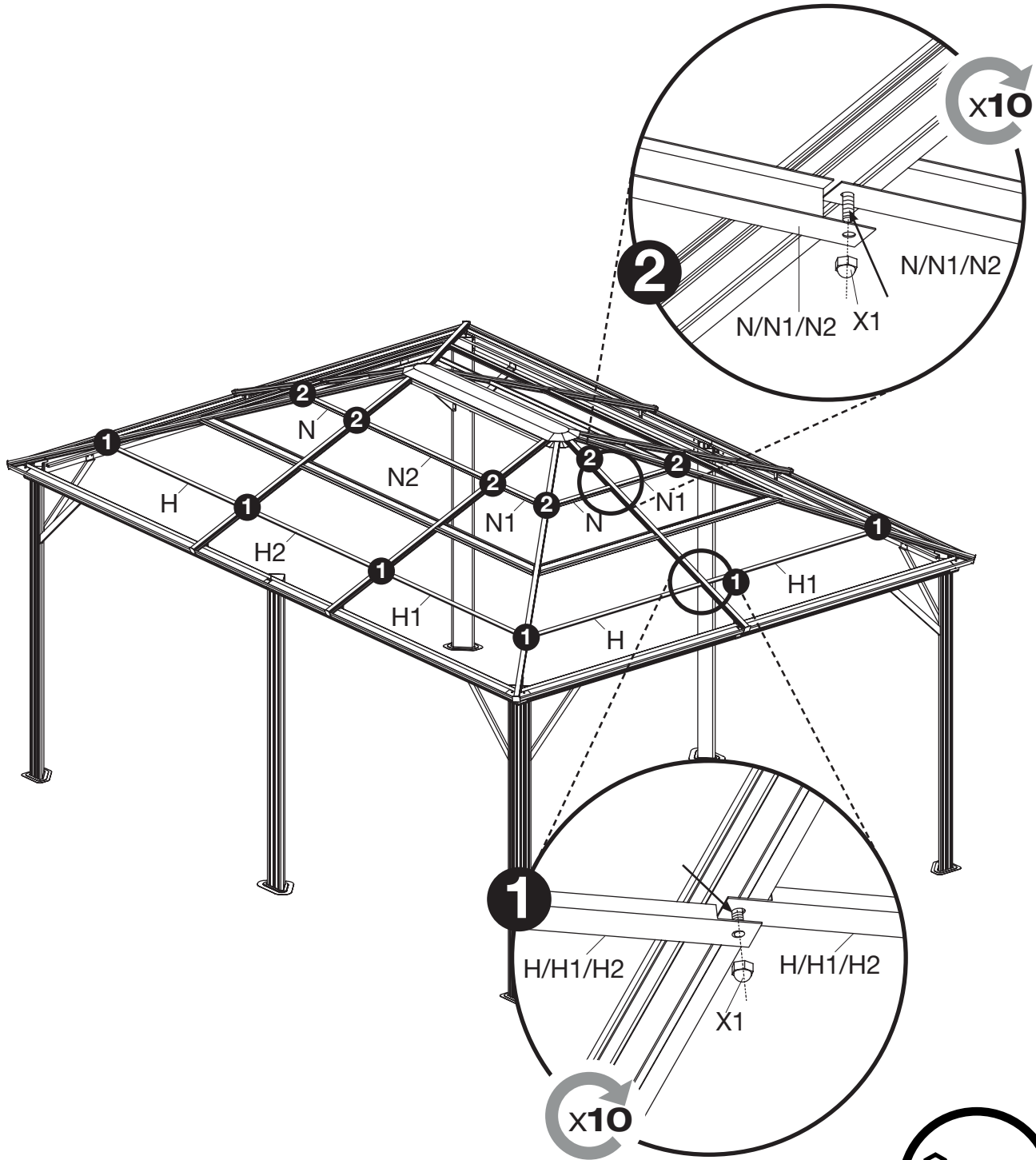

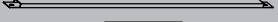
				
I x4	I2 x2			
				
I1 x4	O x4	O1 x6	X x10	X1 x10

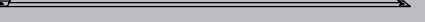

- | | | | |
|---|---|---|--|
| 
Hx4 | 
H2x2 | 
Nx4 | 
X1x20 |
| 
H1x4 | 
N2x2 | 
N1x4 | |

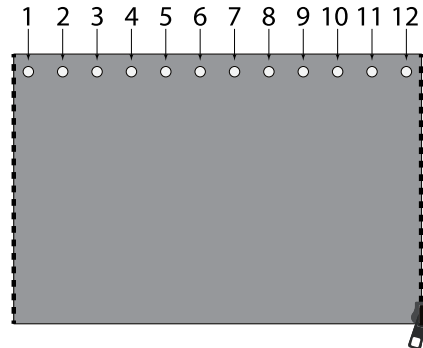
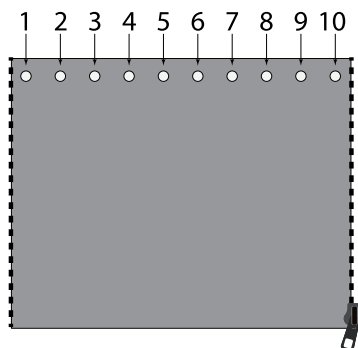
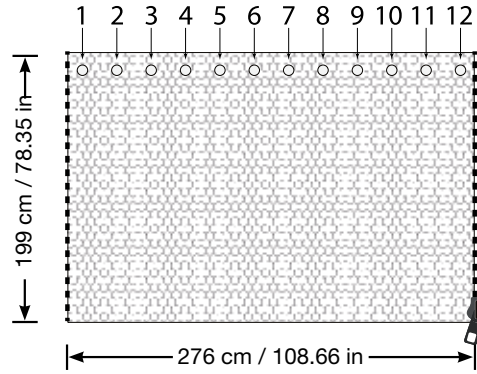
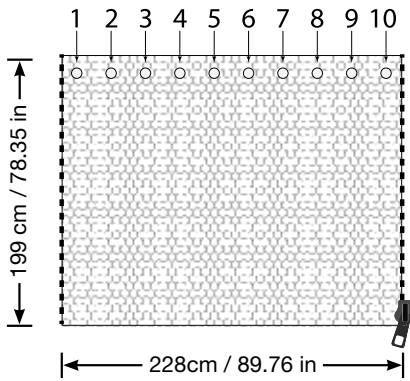
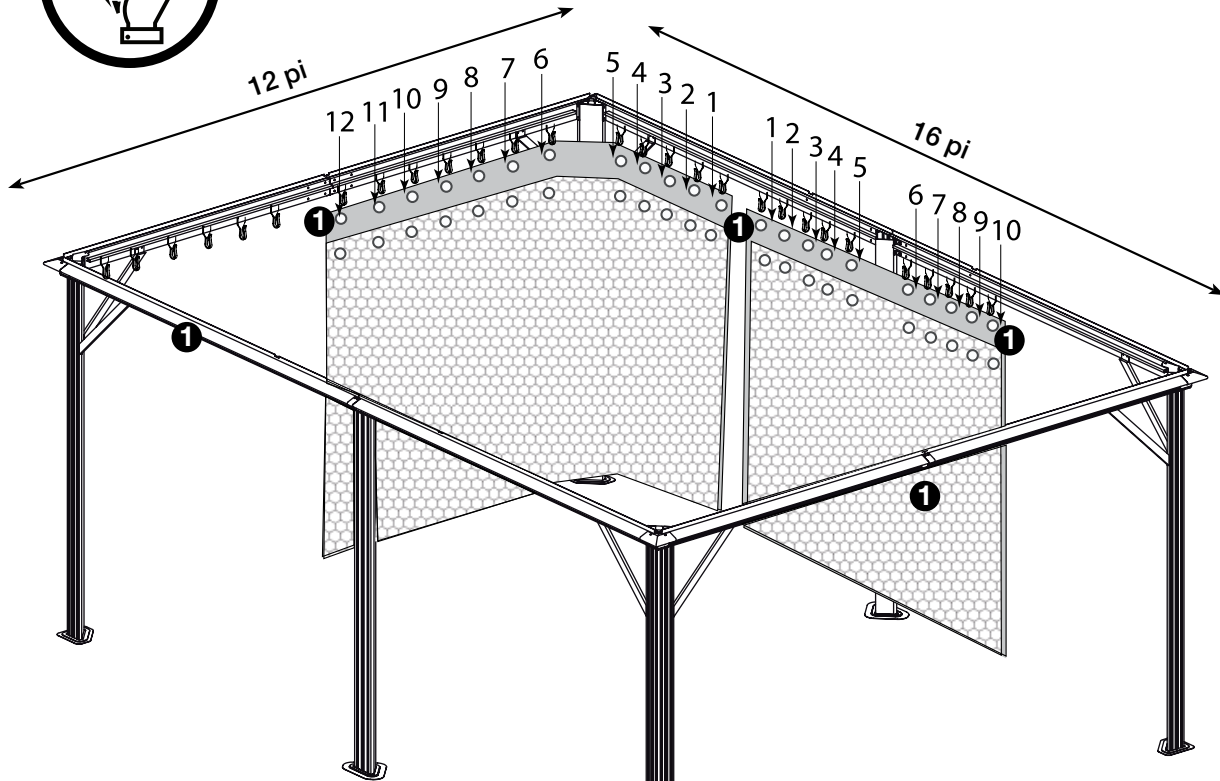

SOJAG ■ I
produits saisonniers • seasonal products